

STAMP

S U N S O U R C E

STS Owners Manual

Operation & Assembly Instructions

Warranty Information



5225 W. 140th Street
Brook Park, OH 44142



Sunsource™

International Tanning Technologies 1-800-832-8267

This product is in conformity with the performance standard for sunlamp products under 21 CFR part 1040.20. This product is compliant with standards UL 482, 7th edition UL 1598, 4th edition, and CAN/CSA-C22.2

3 YEAR LIMITED WARRANTY

International Tanning Technologies, Inc., warrants to the original purchaser, that the Sunsource™ indoor suntanning products (hereafter referred to as the "product") to be free of defects in workmanship and materials for a period of three years from the date of purchase from International Tanning Technologies Inc., its' franchises and authorized distributors. Warranty excludes pistons and acrylics which are warranted for a period of 90 days from the date of purchase. Tanning lamps are warranted by the manufacturer of the lamp itself for a period of 30 days. Within this period we will replace or repair, at our option, the product or any part or parts without charge for materials. Labor will be rendered at no charge for a period of 90 days from the date of purchase. **This warranty does not cover transportation and or shipping costs. This warranty does not cover any product or part thereof subjected to misuse, abuse, accidental or intentional damage or improper maintenance, alteration or where replacement parts not expressly authorized by International Tanning Technologies, Inc. are utilized except as expressly stated herein.**

This limited warranty is in lieu of any other warranties expressed or implied including any implied warranties of merchant ability or fitness; International Tanning Technologies Inc., or its' authorized distributors shall not be liable to purchaser or any user of the product for any injuries to person or property caused directly or indirectly by the product or any part or component thereof.

Purchaser remedies shall be limited to the remedies provided in this limited warranty and shall in no event include any incidental, indirect, special, or consequential damages or loss of use, revenue, or profit even if International Tanning Technologies Inc. has been advised of the possibility of such damages.

In the event of a claim under this limited warranty, purchaser shall contact International Tanning Technologies in writing or by phone at 1-800-832-8267, or your authorized Sunsource distributor within the warranty period. In the event International Tanning Technologies Inc. or its' authorized distributor determine the product or any part thereof requires repair or replacement, purchaser shall be directed to where the product or any part thereof should be shipped for repair or replacement as provided hereunder.

Some states do not permit limitation or exclusion of implied warranties; therefore the limitation or exclusions set forth above may not apply to purchaser. This warranty gives specific legal rights and purchaser may also have other rights which may vary from state to state.

WARNING

All replacement parts should be certified Sunsource™ parts only. Failure to comply may void your warranty. Using non compliant parts may result in a unit malfunction and potential harm to your client!

**ANY MODIFICATIONS TO THE
EQUIPMENT WILL VOID ALL WARRANTIES.**



WARNING

If you have been diagnosed by a physician as being allergic to the sun or are currently taking any photosensitive medications; consult your physician before using this product.

This tanning system is designed for use by one person at a time. Always use the protective eyewear that is provided when tanning.

International Tanning Technologies strongly discourages the use of this product by pregnant women. Although there is no evidence of direct harm caused by UVA/UVB exposure to the women or unborn child, a tanning bed does, however; generate a great deal of heat that may raise your core body temperature.

SKIN TYPES

Determine skin type by the following information:

Skin Type 1: always burns easily and severely, then peels- never tans very fair skin, red or blond hair & freckles

(unexposed skin is white)

Skin Type 2: burn easily, tans minimally or lightly and peels, usually fair skinned (unexposed skin is white)

Skin Type 3: burn moderately, tans eventually (unexposed skin is white)

Skin Type 4: burns minimally, always tans well (unexposed skin is white)

Skin Type 5: rarely burns, always tans readily (unexposed skin is brown)

CAUTION: SOME AREAS OF SKIN MAY NOT HAVE EVER BEEN EXPOSED TO NATURAL SUNLIGHT, THESE AREAS WILL BE VERY SENSITIVE AND WILL BURN VERY EASILY. CARE SHOULD BE TAKEN TO AVOID OVEREXPOSURE TO THESE AREAS, REGARDLESS OF SKIN TYPE.

Determine your skin type and refer to the exposure schedule on the following page. Be patient with your tanning results and NEVER tan more than once in a 24 hour period.

Use only a quality tanning lotion that has been marked for indoor use. Some lotions may contain ingredients that will cloud or damage the acrylic sheet, these must be avoided.

UNIT SPECIFICATIONS

Height: 95" overall

Width: 46.5"

Weight: 1000 lbs.

Room dimensions: (minimum) 8'x6'

NOTE: If actual voltage is not between 220-235 VAC, you will need a buck boost transformer to correct the deficiency in your incoming power. Failure to do so will create undue stress on your unit and will void warranty.

	STS-100w		STS-160w	
Model Booth	5000sts	6000sts	8000sts	9000sts
Lamps	48-100w	56-100w	48-160w	56-160w
Amperage Drawn	28	32	47	55a
Circuit Needed	40a	40a	60a	70a
Required Voltage	235	235	235	235
Required Receptacle	hardwire	hardwire	hardwire	hardwire

DANGER! ULTRAVIOLET RADIATION

FOLLOW INSTRUCTIONS. Avoid overexposure, as with natural sunlight, overexposure can cause eye and skin injury and allergic reactions. Repeated overexposure may cause premature aging of skin and skin cancer.

WEAR PROTECTIVE EYEWARE. FAILURE TO DO SO MAY RESULT IN SEVERE BURNS OR LONG TERM INJURY TO THE EYES. Medications or cosmetics may increase your sensitivity to the ultraviolet radiation. Consult a physician before using a sunlamp if you are using medications or have a history of skin problems or believe yourself to be especially sensitive to sunlight. If you do not tan in the sun you are unlikely to tan from the use of this product. Minimum use distance is 1 inch or 25.4 centimeters. Tanning may appear after one application provided your skin is capable of developing a suntan. Allow 48 hours between sessions to obtain a base tan. Use once or twice a week to maintain appearance. **ONLY THE INDICATED LAMPS HAVE BEEN CERTIFIED FOR USE IN THE SPECIFIED EQUIPMENT.** These products are in conformity with performance standards for sunlamp products under 21 CFR part 1040.20. Recommended eyewear provided eye shields (Lucas products corp., Super Sunnies) or equivalent eyewear as defined under 21 CFR 1040.20 2 (b)(6). One pair of protective eyewear is furnished with this equipment and should be worn by all person in the room when lamps are on. **DISCONNECT POWER CORD BEFORE ATTEMPTING TO CLEAN, RELAMP, OR ENGAGE IN THE MAINTENANCE OF THIS PRODUCT.**

WARNING: Read the instruction booklet before using lamps. When using this booth, stand directly in the center area and close doors. Operation of this device below recommended minimum distance for use may result in overexposure.

TROUBLESHOOTING

- Unit will not turn on , timer does not light up
 - Unit not plugged in or connected properly
 - Breaker is not on
 - Timer is not set or remote timer is not set or hooked up properly
 - Incoming voltage is not correct
 - Possible faulty or loose wire or component, contact Service Department
- One or more panels will not light
 - Panel is not plugged into panel before it
 - Possible faulty or loose wire or component, contact Service Department
- Lamp will not light
 - Lamp not properly installed
 - Faulty lamp
 - Faulty starter or socket
 - Faulty ballast
 - Possible faulty or loose wire or component, contact Service Department
- Unit running extremely hot
 - Incorrect voltage
 - Improper ventilation or room too small
 - Fan clogged or not working
- Lamps not tanning
 - Lamps, and reflectors are dirty
 - Incorrect voltage
 - Lamps are worn out
- Unit will not turn off
 - Faulty timer or contactor, Contact Service Department
- Fan does not work
 - White cord not plugged in from fan
 - Faulty fan delay relay
 - Faulty fan
 - Incorrect voltage to fan

ASSEMBLY INSTRUCTIONS

1) Set floor panel in desired location leaving at least 16" from the wall on all sides. Place floor assembly with #1 and #2 towards rear. Center the two front hinge tubes on the room, this is where your door will be. Level booth floor, side to side, then front to rear. Use wood shims if necessary.

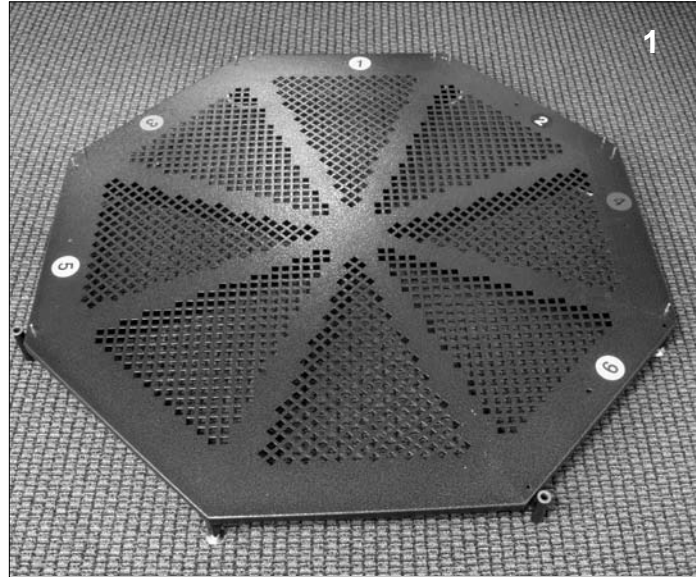

2) Set panel #1 in place and secure bottom nut using a 9/16" wrench or socket. Check to see if cords will reach your receptacle or buck boost at this time.

3) Set panel #2 in place and secure bottom nut using a 9/16" wrench or socket. Install corner cover using the screws provided. Repeat for panels #3 - #6.



4) With the flange towards the front doors and the fan cord to the rear, set the fan panel on top of unit and secure with screws to each of the lamp panels. Plug in white fan cord to white cord coming from the back of panel 1. Attach hinge brackets to panel 6 and 7 with the bolts provided.



ASSEMBLY INSTRUCTIONS

(continued)

5) The hinge comes attached to the door. Attach the other side of the hinge to the panel next to it with the #10-32 black screws that are provided.

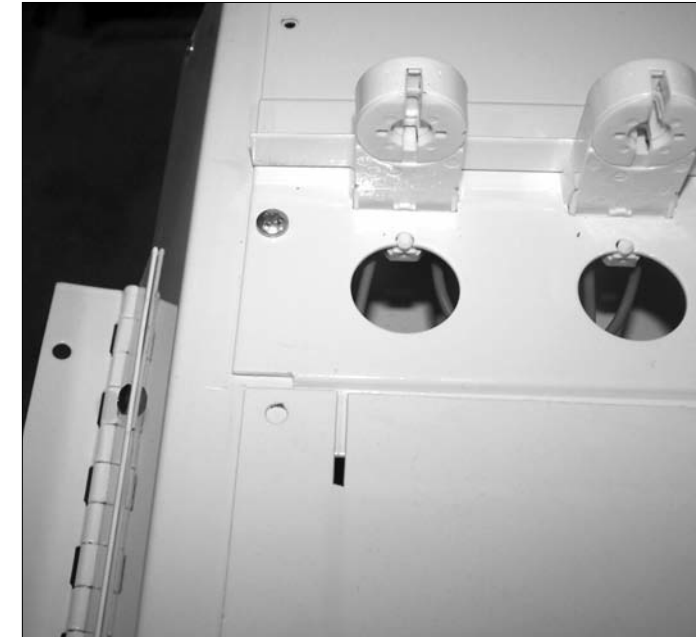

6) Plug in all connector cords at this time.

7) Attach door top covers and 2 piece panel top covers with screws provided.

8) Connect power supply and test unit by setting timer and pushing the "Start" button

9) This unit must have between 220-240 volts, no higher and no lower. Please have your electrician check your actual voltage at the receptacles. If voltage is not in this range, your equipment will not perform as designed and may void any and all warranties. Proper voltage is key in lamp life, lamp output, fan performance and component performance.

SUNSOURCE

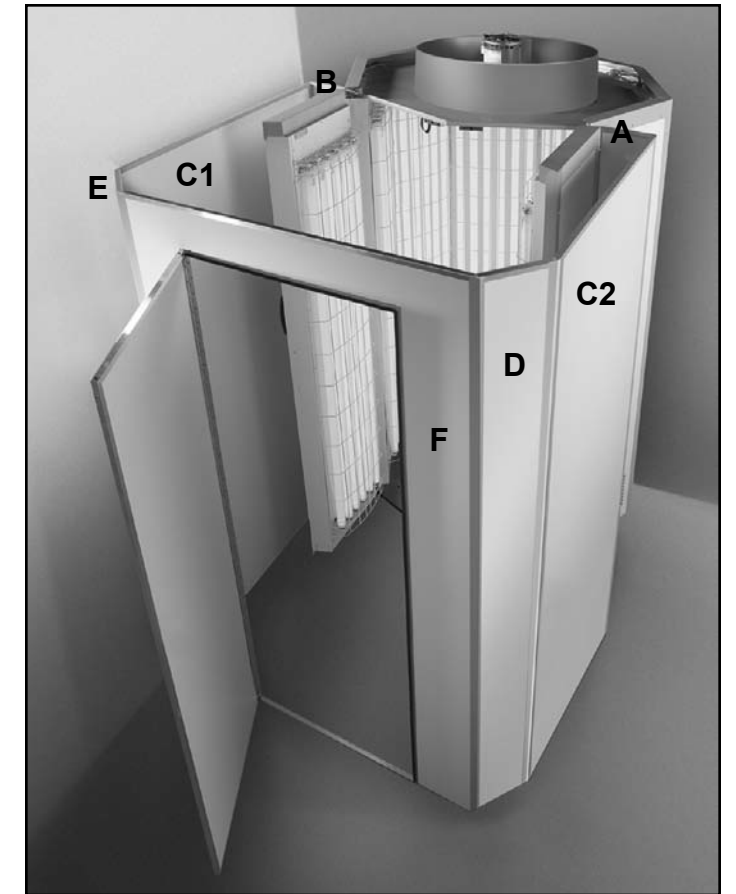

CHANGING ROOM INSTALLATION

1) Install changing room panel A to BOOTH using the screws provided and the angled cover bracket. Align bracket CRLS along the hinge assembly on the LEFT side.

2) Secure changing room panel B to booth panel using the screws provided and the angled cover bracket. Align bracket CRRS along the hinge on the RIGHT side.

3) Install side panels C1 and C2 into back corner angles A and B.

4) Secure front corner angles D and E to front door panel E.

5) Attach front door panel with corner angle attached. Be sure the unit is level and plumb, secure all points, inside and out with screws provided.

10 MINUTE 56-100w Lamps

Light Sources Equator Sun XL(100w),
Light Sources Beach Sun Reflector
6.5 (100w) Cosmedico Hi-Tan100w or
FDA equivalent.

RECOMMENDED EXPOSURE SCHEDULE			MAXIMUM EXPOSURE TIME IN MINUTES				
Skin Type			Week 1 1st-3rd sessions	Week 2 4th-6th sessions	Week 3 7th-9th sessions	Week 4 10th-12th sessions	Maximum Subsequent sessions
I	Sensitive Skin	Burns easily and severely- does not tan.	Not Recommended for tanning				
II	Light Skin	Burns easily and tans minimally.	2	4	6	8	10
III	Normal Skin	Burns moderately and tans moderately.	3	6	8	10	10
IV	Dark Skin	Burns minimally and tans above average.	5	7	9	10	10
V	Very Dark Skin	Rarely burns, tans easily and substantually.	6	8	9	10	10

12 MINUTE 48-100w Lamps

Light Sources Equator Sun XL(100w),
Light Sources Beach Sun Reflector
6.5 (100w) Cosmedico Hi-Tan100w or
FDA equivalent.

RECOMMENDED EXPOSURE SCHEDULE			MAXIMUM EXPOSURE TIME IN MINUTES				
Skin Type			Week 1 1st-3rd sessions	Week 2 4th-6th sessions	Week 3 7th-9th sessions	Week 4 10th-12th sessions	Maximum Subsequent sessions
I	Sensitive Skin	Burns easily and severely- does not tan.	Not Recommended for tanning				
II	Light Skin	Burns easily and tans minimally.	2	4	8	10	12
III	Normal Skin	Burns moderately and tans moderately.	3	6	9	12	12
IV	Dark Skin	Burns minimally and tans above average.	5	7	10	12	12
V	Very Dark Skin	Rarely burns, tans easily and substantually.	7	9	11	12	12

9 MINUTE STS Elite

56-160w Lamps
Cosmedico C71/VHR/160w or
Signature Series Plus FR71
160w FDA equivalent.

RECOMMENDED EXPOSURE SCHEDULE			MAXIMUM EXPOSURE TIME IN MINUTES				
Skin Type			Week 1 1st-3rd sessions	Week 2 4th-6th sessions	Week 3 7th-9th sessions	Week 4 10th-12th sessions	Maximum Subsequent sessions
I	Sensitive Skin	Burns easily and severely- does not tan.	Not Recommended for tanning				
II	Light Skin	Burns easily and tans minimally.	1	3	5	7	9
III	Normal Skin	Burns moderately and tans moderately.	2	4	6	8	9
IV	Dark Skin	Burns minimally and tans above average.	4	6	7	9	9
V	Very Dark Skin	Rarely burns, tans easily and substantually.	5	6	8	9	9

10 MINUTE 48-160w Lamps

Light Sources Signature Series
Plus/60pw, Cosmedico VHR160w
or FDA equivalent.

RECOMMENDED EXPOSURE SCHEDULE			MAXIMUM EXPOSURE TIME IN MINUTES				
Skin Type			Week 1 1st-3rd sessions	Week 2 4th-6th sessions	Week 3 7th-9th sessions	Week 4 10th-12th sessions	Maximum Subsequent sessions
I	Sensitive Skin	Burns easily and severely- does not tan.	Not Recommended for tanning				
II	Light Skin	Burns easily and tans minimally.	2	4	6	8	10
III	Normal Skin	Burns moderately and tans moderately.	3	6	8	10	10
IV	Dark Skin	Burns minimally and tans above average.	5	7	9	10	10
V	Very Dark Skin	Rarely burns, tans easily and substantually.	6	8	9	10	10

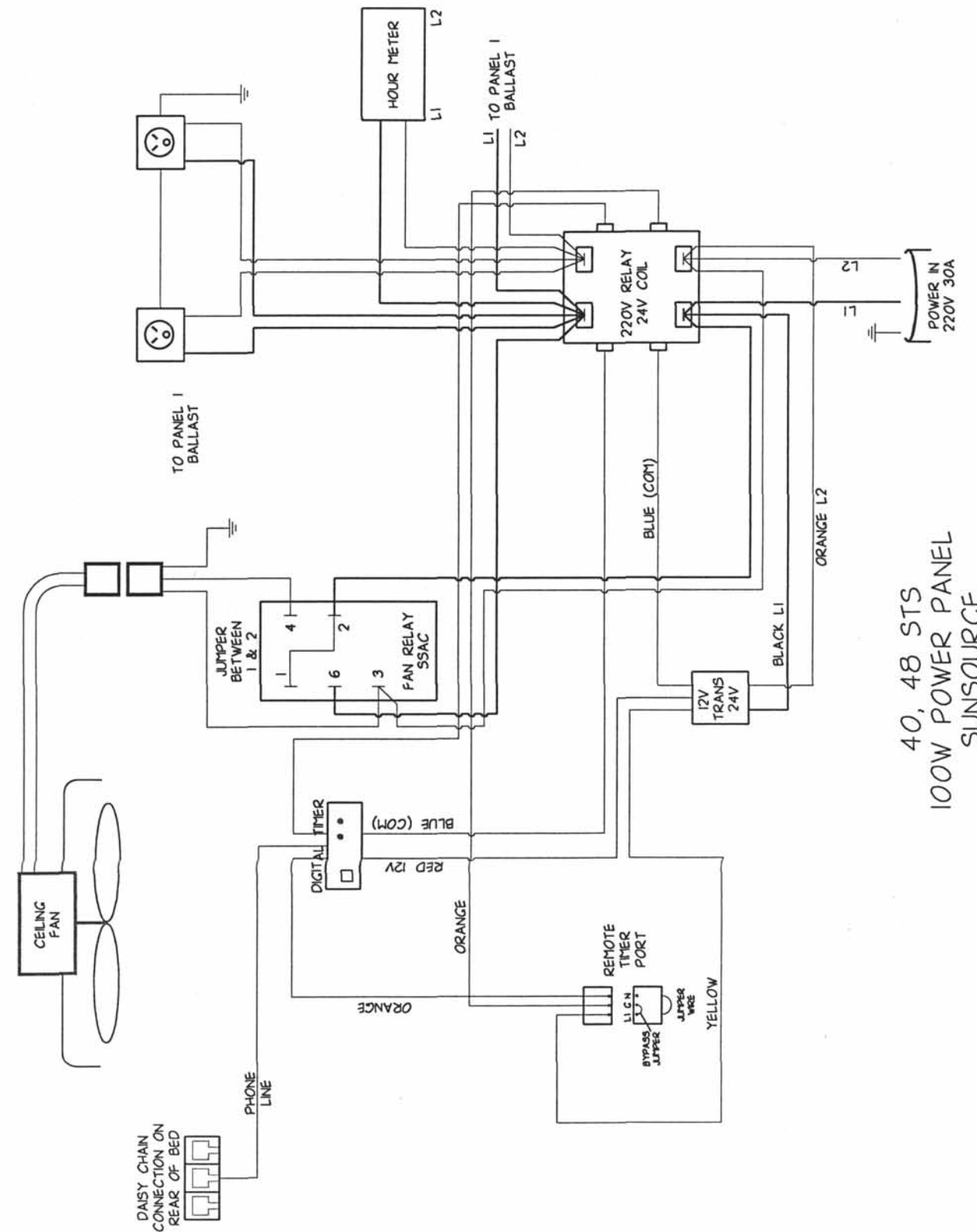

STSV chart see page 15.

40, 48 STS
100W POWER PANEL
SUNSOURCE
INTERNATIONAL TANNING TECHNOLOGIES
CLEVELAND, OHIO
800-832-8267

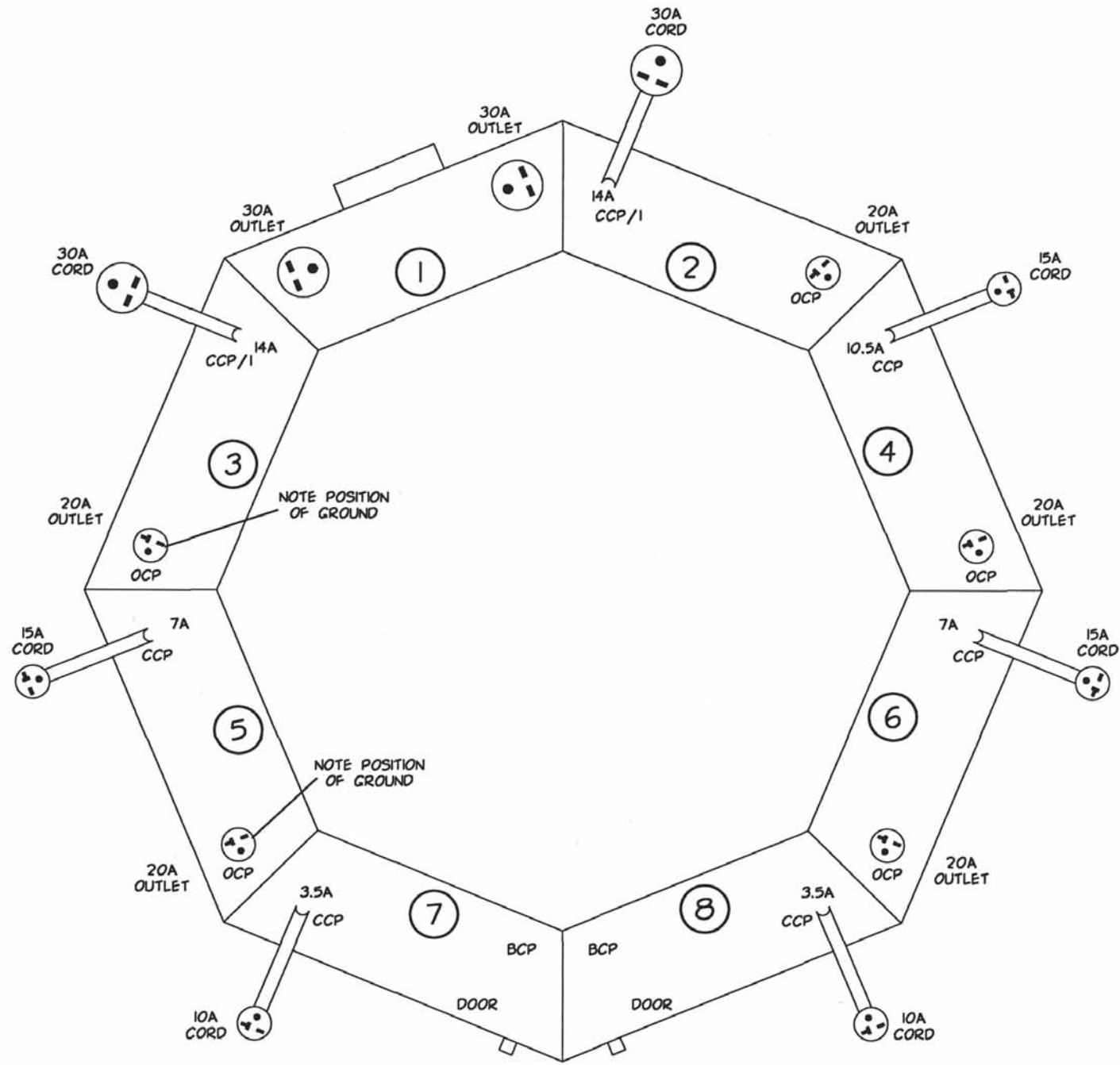

48 STS
100W
INTERNATIONAL TANNING TECHNOLOGIES
CLEVELAND, OHIO
800-832-8267

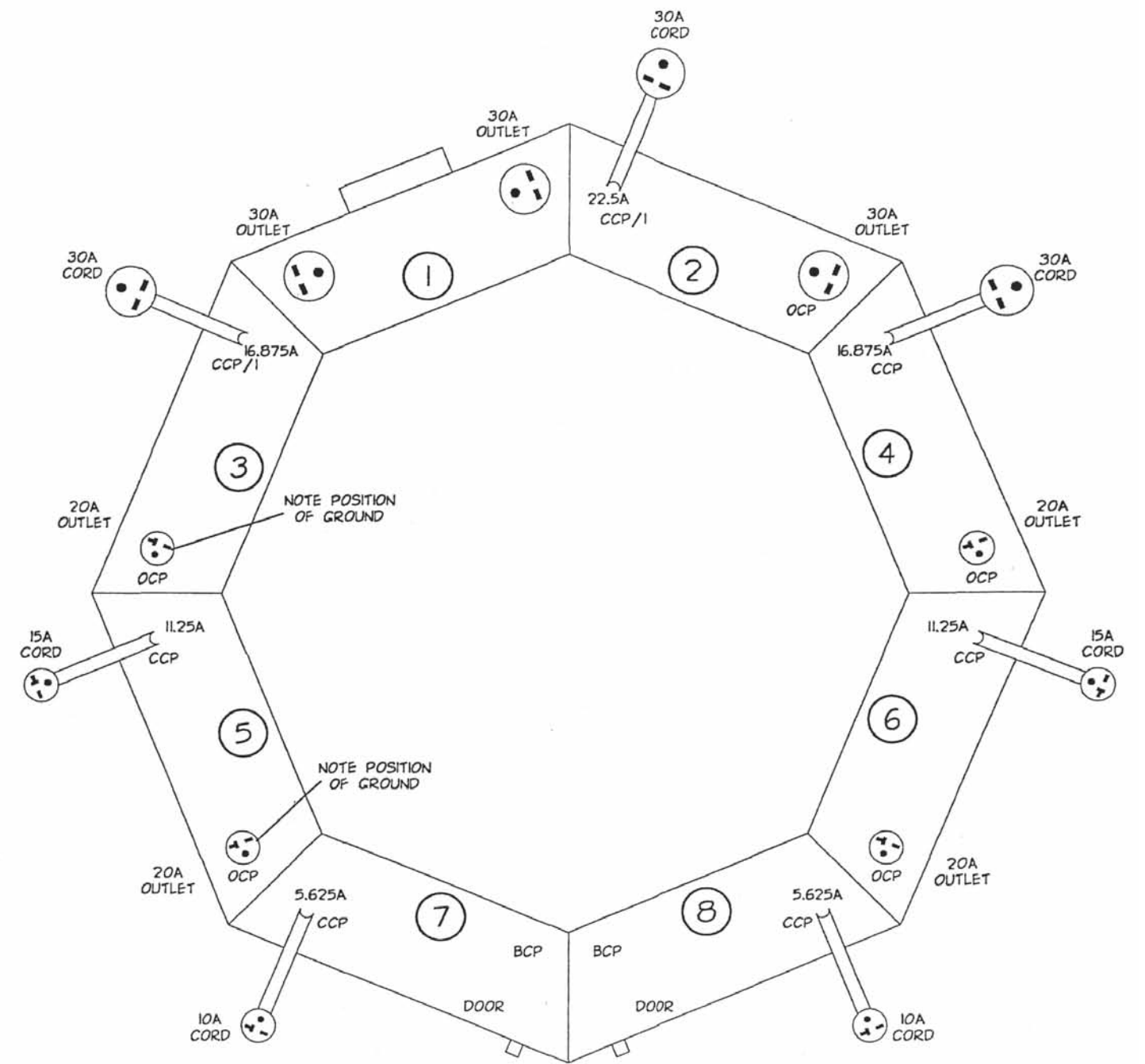

48 STSV
160W
INTERNATIONAL TANNING TECHNOLOGIES
CLEVELAND, OHIO
800-832-8267

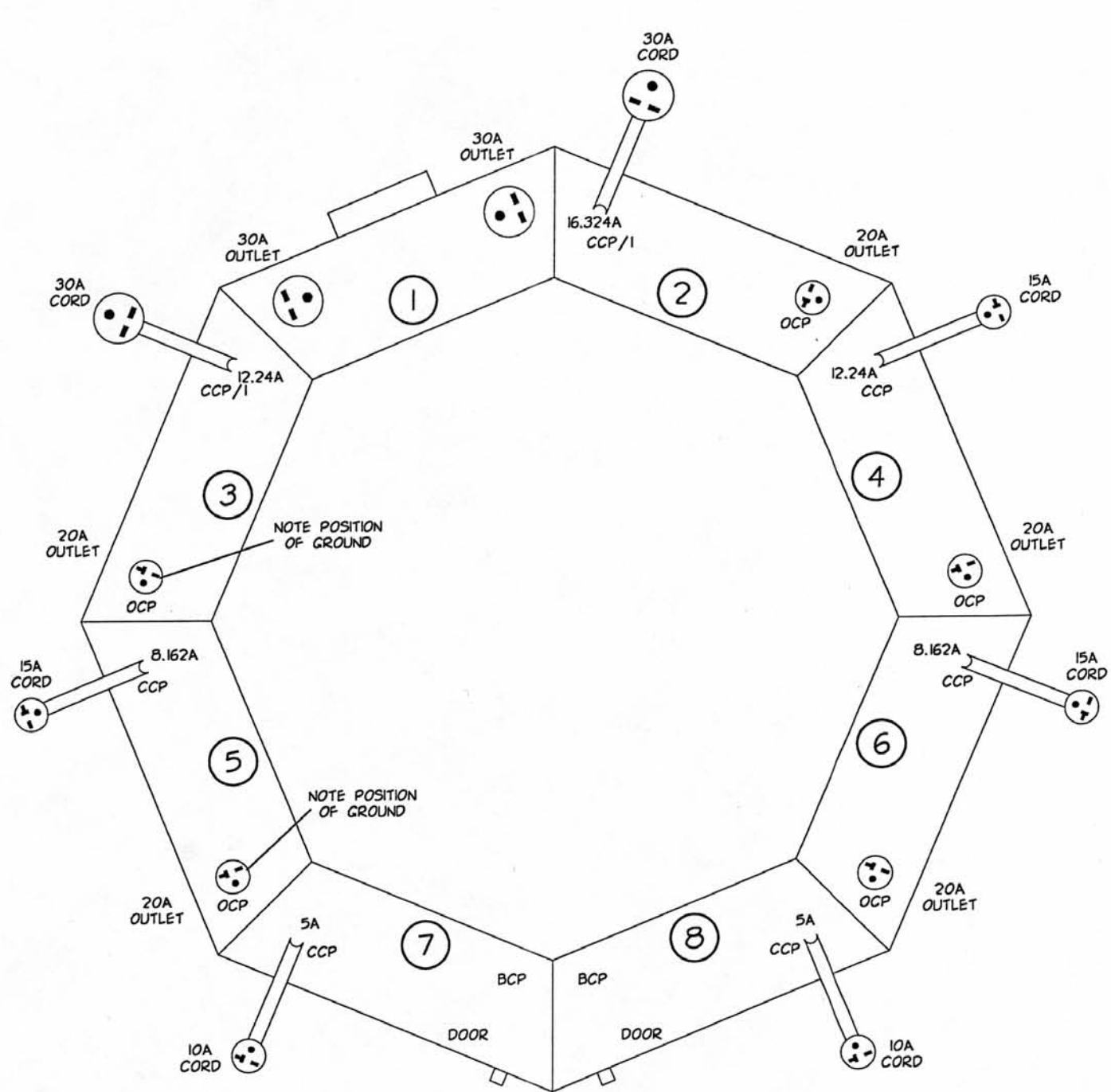

56 STS
100W
INTERNATIONAL TANNING TECHNOLOGIES
CLEVELAND, OHIO
800-832-8267

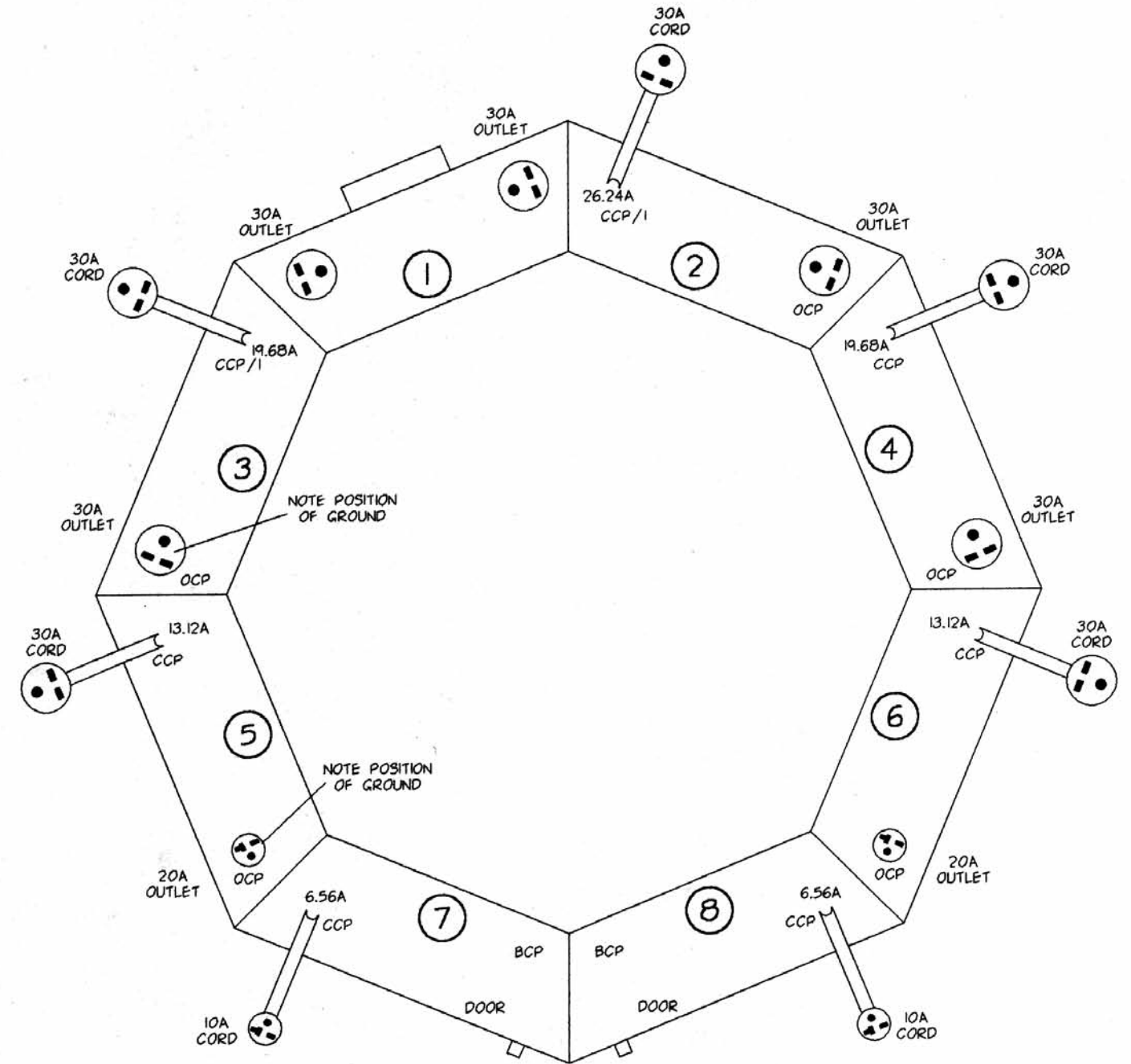

56 STSV
160W
INTERNATIONAL TANNING TECHNOLOGIES
CLEVELAND, OHIO
800-832-8267

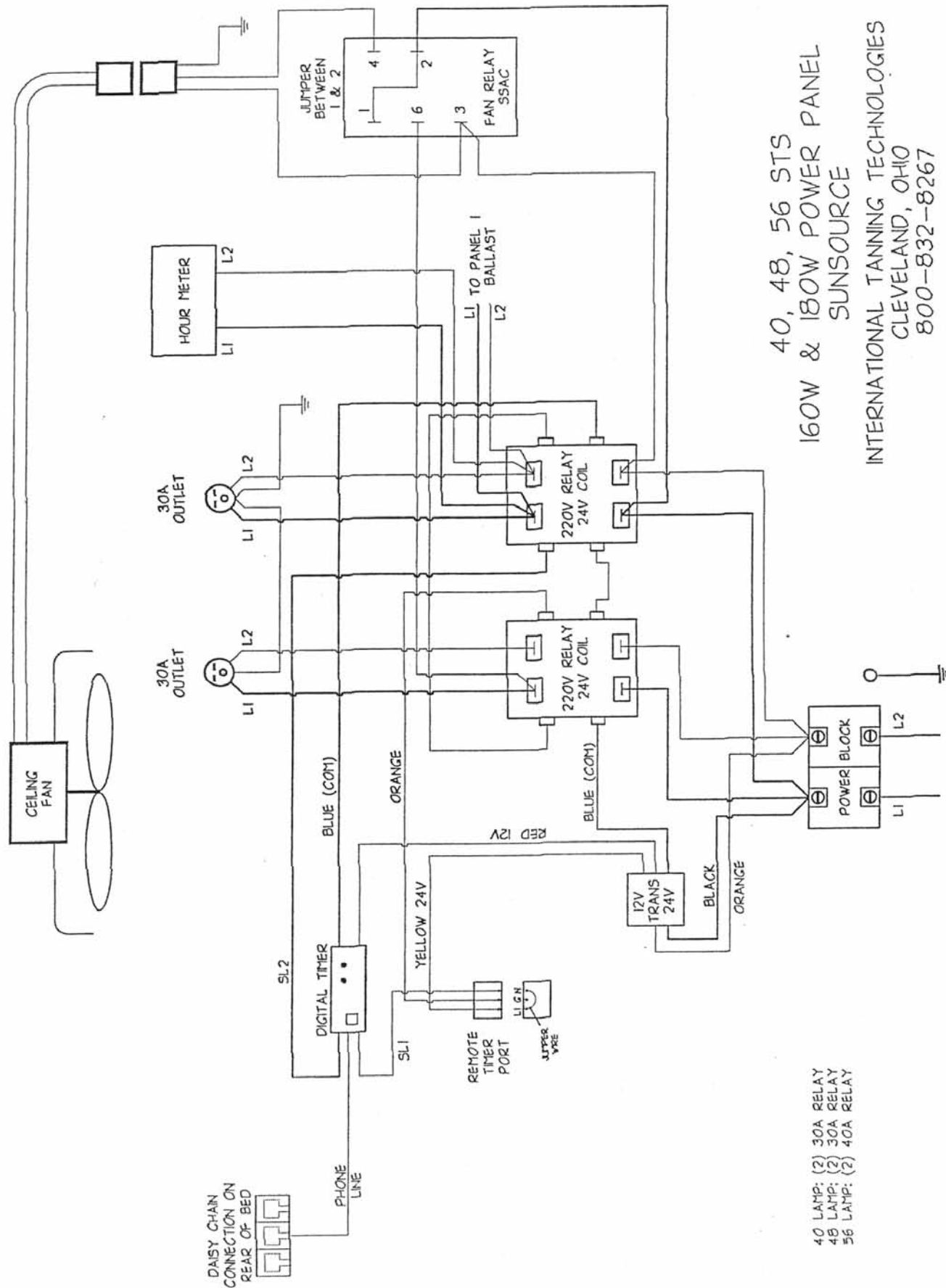

Sunsorce™

3 YEAR LIMITED WARRANTY CARD

Important: Mail Warranty Card Now!

Name of Purchaser:

Date Purchased:

Name of Business:

Address:

Phone: ()

City:

State: Zip:

E-mail:

Distributor:

Model#:

Serial #:

Please fill out warranty card, cut along dotted line to the left, fold upward and tape at top.
Post office will not deliver without postage.

International Tanning Technologies
1-800-832-8267

WARNING
All replacement parts should be certified Sunsource™ parts only. Failure to comply may void your warranty. Using non compliant parts may result in a unit malfunction and potential harm to your client!

ANY MODIFICATIONS TO THE EQUIPMENT WILL VOID ALL WARRANTIES.